



OWNER'S MANUAL

STYLER



Before beginning installation, read these instructions carefully. This will simplify installation and ensure that the product is installed correctly and safely. Leave these instructions near the product after installation for future reference.

ENGLISH

S3*F(*)



MFL66101295
Rev.00_031921

www.lg.com

Copyright © 2021 LG Electronics Inc. All Rights Reserved.

TABLE OF CONTENTS

This manual may contain images or content that may be different from the model you purchased.
This manual is subject to revision by the manufacturer.

SAFETY INSTRUCTIONS

READ ALL INSTRUCTIONS BEFORE USE.....	3
WARNING STATEMENTS	3

INSTALLATION

Parts and Specifications	10
Installation Place Requirements	12
Unpacking the Appliance	14
Levelling the Appliance	15

OPERATION

Operation Overview.....	18
Preparing Loads	18
Checking the Items before Every Load	20
Loading the Appliance.....	21
Control Panel	28
Programme Table	30
Option Programmes and Extra Functions	34

SMART FUNCTIONS

LG ThinQ Application	36
Smart Diagnosis	38

MAINTENANCE

Regular Cleaning.....	39
-----------------------	----

TROUBLESHOOTING

Before Calling for Service.....	41
---------------------------------	----

SAFETY INSTRUCTIONS

READ ALL INSTRUCTIONS BEFORE USE

The following safety guidelines are intended to prevent unforeseen risks or damage from unsafe or incorrect operation of the appliance. The guidelines are separated into 'WARNING' and 'CAUTION' as described below.

Safety Messages



This symbol is displayed to indicate matters and operations that can cause risk.

Read the part with this symbol carefully and follow the instructions in order to avoid risk.



WARNING

This indicates that the failure to follow the instructions can cause serious injury or death.



CAUTION

This indicates that the failure to follow the instructions can cause the minor injury or damage to the appliance.

WARNING STATEMENTS



WARNING

- To reduce the risk of fire or explosion, electric shock, property damage, injury to persons or death when using this appliance, follow basic safety precautions, including the following:

Technical Safety

- This appliance is not intended for use by persons (including children) with reduced physical, sensory or mental capabilities, or lack of experience and knowledge, unless they have been given supervision or instruction concerning use of the appliance by a person responsible for their safety.

4 SAFETY INSTRUCTIONS

- Children should be supervised to ensure that they do not play with the appliance.
- Do not, under any circumstances, cut or remove the ground prong from the power cord. To prevent personal injury or damage to the appliance, the electrical power cord must be plugged into a properly grounded outlet.
- This appliance must be plugged into a 220-240 VAC, 50-Hz grounded outlet protected by a 15-ampere fuse or circuit breaker. Failure to follow these instructions can result in fire, explosion, or death.
- This appliance must be plugged into a properly grounded outlet. Electrical shock can result if the appliance is not properly grounded. Have the wall outlet and circuit checked by a qualified electrician to make sure the outlet is properly grounded. Failure to follow these instructions can create an electric shock hazard and/or a fire hazard.
- Install the appliance where the plug is easily accessible. Unplug the appliance when not in use to avoid risk of fire or electric shock.
- Unplug the appliance before disassembly or repair to avoid risk of electric shock.
- The appliance should always be plugged into its own individual electrical outlet which has a voltage rating that matches the rating plate. This provides the best performance and also prevents overloading house wiring circuits which could cause a fire hazard from overheated wires.
- Do not use an extension cord to connect to an outlet. Doing so could result in a fire or electric shock.
- Never unplug your appliance by pulling on the power cord. Always grip the plug firmly and pull straight out from the outlet. The power cord can be damaged, resulting in a risk of fire and electric shock.
- Contact LG or a qualified repair person immediately to repair or replace all power cords that have become frayed or otherwise damaged. Do not use a cord that shows cracks or abrasion damage along its length or at either end. The power cord can melt, creating electric shock and/or fire hazard.

- When installing or moving the appliance, be careful not to pinch, crush, or damage the power cord. This will prevent injury and damage to the appliance from fire and electric shock.

Installation

- When moving the appliance away from the wall, be careful not to roll over or damage the power cord.
- The appliance is heavy. Two or more people are necessary to move and install the appliance to prevent damage or injury.
- Prior to use, ensure that you are connecting the appliance to a dedicated grounded electrical outlet rated for use with the appliance. It is the user's responsibility to replace a standard 2-prong wall outlet with a standard 3-prong wall outlet.
- Before use, the appliance must be properly installed as described in this manual. Electric shock can result if the appliance is not properly grounded.
- Do not install the appliance where there may be a danger of the appliance falling. The appliance is not designed for use on transportations such as ship and airplane. Check with an authorized LG service centre for use under other special circumstances.
- Do not tamper with controls.
- Install the appliance where the floor is firm and level. The appliance may vibrate excessively and eventually fall if installed on an unstable surface, causing damage or injury.
- Do not truck the appliance from the front side and keep the front side protected always. Failure to do so the tempered glass on the appliance may be broken.
- Properly ground the appliance to conform with all governing codes and ordinances. Follow the details in the installation instructions.
- Install and store the appliance where it will not be exposed to temperatures below freezing or exposed to the weather. Allow the appliance to warm to room temperature before use if it was delivered in winter or at sub-zero temperature.

- Do not repair or replace any part of the appliance or attempt any servicing unless specifically recommended in the user-maintenance instructions or in published user-repair instructions that you understand and have the skills to carry out.
- To reduce the risk of electric shock, do not install the appliance in humid spaces such as a bathroom. Failure to follow this warning can cause death, serious injury, fire, electric shock, or product deformation or malfunction.
- Remove all packing items and dispose of all shipping materials properly.
- Connect to a properly rated, protected, and sized power circuit to avoid electrical overload. Improper power circuits can melt, creating electric shock and/or fire hazard.
- If the supply cord is damaged, it must be replaced by the manufacturer or its service agents or similarly qualified person in order to avoid a hazard.
- Keep all packaging from children. Packaging material can be dangerous for children.
- Do not install near another heat source such as a stove, oven or heater.
- Do not place candles, smoking materials, or other flammables on top of the appliance.
- Remove all protective vinyl film from the appliance.
- The appliance shall be installed in accordance with national wiring regulations.

Operation

- Do not allow children to play on or in the appliance. Close supervision of children is necessary when the appliance is used near children.
- Do not climb, stand, or hang on the appliance door or on the shelf or anywhere inside the appliance.
- Do not step on the doors to the water tanks.
- Do not place heavy or dangerous objects on top of the appliance.

- Do not put live animals inside the appliance.
- Do not allow children to climb into the appliance.
- In the event of a gas leak (propane/LPG), ensure adequate ventilation and contact an authorized service centre before resuming use. Do not touch or disassemble the electrical outlet of the appliance.
- Do not use or place flammable substances (chemicals, medicine, cosmetics, etc.) near the appliance or store them inside the appliance. Do not place the appliance in the vicinity of flammable gas.
- Disconnect the power cord immediately if you hear a noise, smell a strange odour or detect smoke coming from the appliance.
- In the event of a flood, do not go near the appliance and contact an authorized service centre.
- Do not use fabric softeners or products to eliminate static unless recommended by the manufacturer of the fabric softener or product.
- Do not place hands or body near steam nozzle during operation. The steam is hot and could cause an injury.
- Do not insert objects into the steam nozzle.
- Do not drink the water from the water drain and supply tanks.
- Do not disassemble or modify the appliance.
- Do not put hands, feet, or metal objects below the appliance.
- Do not operate the appliance or touch the power cord with wet hands.
- Keep fingers out of pinch point areas; clearances between the door and cabinet are necessarily small. Be careful closing door when children are nearby.
- Do not place items exposed to cooking oils in the appliance. Items contaminated with cooking oils may contribute to a chemical reaction that could cause a load to catch fire.
- Do not dry articles that have been previously cleaned in, washed in, soaked in, or spotted with gasoline, dry-cleaning solvents, or other flammable or explosive substances, as they give off vapors that could ignite or explode.

- Do not use heat to dry articles containing foam rubber or similarly textured rubber-like materials.
- Do not open door during operation. The performance of the appliance may be adversely affected. If the appliance is installed on or near carpet, condensation from escaping hot air or steam may stain or damage the carpet.
- Damage incurred by using the appliance for purposes other than those specified in this user manual is not covered by the warranty.

Maintenance

- Wipe foreign objects (such as dust and water) off the prongs of the power plug and contact areas regularly. Do not use a wet or damp cloth when cleaning the plug.
- Do not use an appliance to dry the interior. Do not light a candle to remove interior odours.
- Do not spray water onto the appliance directly when cleaning. A fire or electric shock may occur.
- Wipe the interior with a dry cloth after use.
- Clean the lint filter before or after each load.
- Do not use a bleaching agent such as oxygen or chlorine-based bleaches on the exterior of the appliance.
- Do not use sharp objects when cleaning or operating the controls. An electric shock may occur.
- Avoid hitting the front glass panel with heavy objects. Although it is made of tempered glass, the panel may break in the event of a strong impact and cause injury.
- Keep product free from rodents, insects, and other foreign objects. They may damage wires, causing fire or electric shock.

Disposal

- Before the appliance is removed from service or discarded, remove the door to the drying compartment. Cut off the power plug and destroy the button section to prevent reuse.

Grounding instructions

- Improper connection of the equipment-grounding conductor can result in a risk of electric shock. Check with a qualified electrician or service person if you are in doubt that the appliance is properly grounded.
- This appliance must be grounded. In the event of malfunction or breakdown, grounding will reduce the risk of electric shock by providing a path of least resistance for electric current.
- This appliance must be equipped with a cord having an equipment grounding conductor and a grounding plug. The plug must be plugged into an appropriate outlet that is properly installed and grounded in accordance with all local codes and ordinances.
- Do not modify the plug. If it does not fit the outlet, have a proper outlet installed by a qualified electrician.
- This appliance must be connected to a grounded metal, permanent wiring system or an equipment-grounding conductor must be run with the circuit conductors and connected to the equipment grounding terminal or lead on the appliance. Electric shock can result if the appliance is not properly grounded.

INSTALLATION

Parts and Specifications

NOTE

- Appearance and specifications may vary without notice to improve the quality of the appliance.

Interior

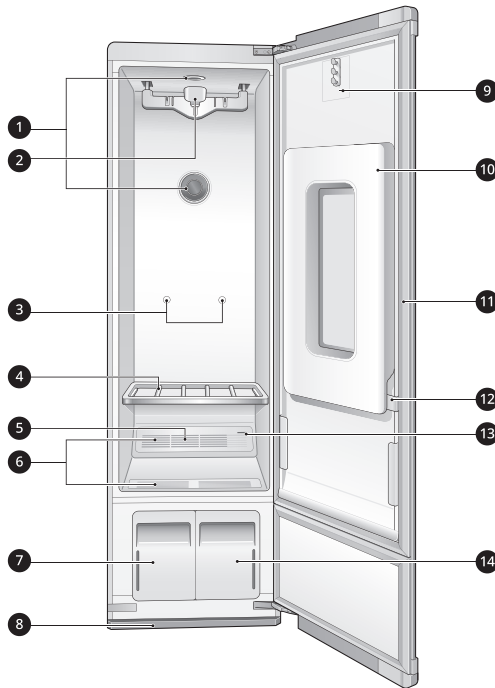

- ❶ Interior light
- ❷ Moving hanger
- ❸ Shelf holder
- ❹ Shelf
- ❺ Aroma filter
- ❻ Hot air circulation vent
- ❼ Water drain tank
- ❽ Drip tray
- ❾ Hooks for pants crease care

- ❿ Pants crease care
- ⓫ Door*¹
- ⓬ Clip
- ⓭ Steam nozzle
- ⓮ Water supply tank

*1 The door swing can be reversed by the installer to fit the installation location.

Specifications

Asterisk(s) means model variant and can be varied (0-9) or (A-Z).

Model	S3*F(*)
Power Supply	220 - 240 V~, 50 Hz
Dimensions (Width × Depth × Height)	445 mm × 585 mm × 1850 mm, 1010 mm (Depth with door open)
Product weight	78 kg
Power consumption	1700-1900W
Maximum capacity	4 items

Accessories

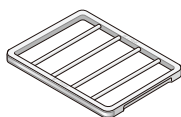

Shelf



Drip tray



2 pieces of Hangers

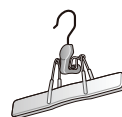

Pants Hanger



2 pieces of Anti-Slip Sheets



2 pieces of Rear cap covers



Anti-tip kit



Wrench



2 pieces of Hinge Covers

NOTE

- The included accessories vary depending on the model you purchased.
- Contact the store where the appliance was purchased or LG customer service if any accessories are damaged or missing.
- For your safety and for extended product life, use only authorized components. The manufacturer is not responsible for product malfunction or accidents caused by the use of separately purchased unauthorized components or parts.

Installation Place Requirements

Before installing the appliance, check the following information to make sure that the appliance should be installed in a correct place.

Dimensions

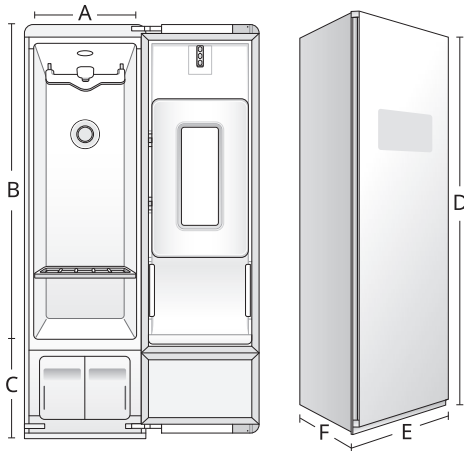

	Dimensions (mm)
A	385
B	1435
C	415
D	1850
E	445
F	585

Installation Location

- A grounded electrical outlet should be located within 61 cm of either side of the appliance.
- Install the appliance on a flat floor. (Allowable slope under the appliance: 1°)
- The floor must be level, with a maximum slope of 2.5 cm under the appliance. If the slope is greater than 2.5 cm, the appliance cannot be levelled properly.

- Ensure that when the appliance is installed, it is easily accessible for an engineer in the event of a breakdown.
- Do not install the appliance in an area where it will be exposed to water and/or weather. Failure to follow this warning could result in risk of electric shock, injury, or product damage or malfunction.
- Do not install the appliance on a hollow or flexible platform. Doing so may cause excessive noise and vibration and result in damage or injury if the appliance tips over.

NOTE

- A sturdy floor should support the total appliance weight of **78 kg**. The combined weight of any other laundry appliances should also be considered.

Recommended Installation Spacing

The following clearances are recommended for the appliance. Although the appliance has been tested for clearances of 3 cm on the sides and rear, recommended clearances should be considered for the following reasons:

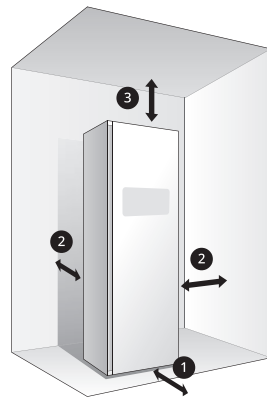

- ① Allow at least **46 cm** in front to open the door.
- ② Allow at least **5 cm** on both sides and between the back of the appliance and the wall.

- 3 Allow at least **20 cm** between the top of the appliance and any overhanging shelves or cabinets.

NOTE

- If the appliance is too close to adjacent items, performance may decrease and electricity consumption may increase.
- Additional space should be considered on all sides of the appliance to reduce noise transfer.

Installation Spacing for Recessed Area or Closet Installation

There should be at least a little space around the appliance (or any other appliance) to avoid contact with walls, furniture, or other appliances during operation. Allow a minimum of 3 cm on all sides of the appliance to avoid increased noise or damage.

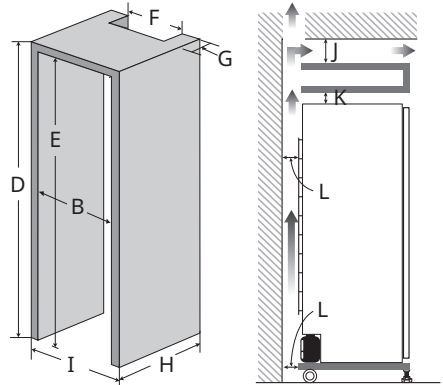
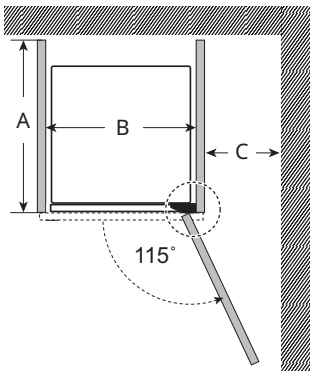

	Dimensions (mm)
A	650
B	≥ 455
C	≥ 250
D	≥ 1889
E	≥ 1875
F	≥ 400
G	≥ 50
H	≥ 630
I	≥ 485
J	≥ 50
K	≥ 20
L	≥ 30

NOTE

- For closet installation, with a door, minimum ventilation openings in the top and bottom of the door are required. Louvered doors with equivalent ventilation openings are acceptable.
- Minimum vent opening for built-in installation is 200 cm².

Closet Ventilation Requirements

Closets with doors must have both an upper and lower vent to prevent heat and moisture build-up in the closet.

One example shown uses vent grilles in the door.

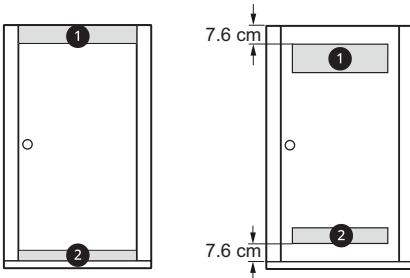

- 1 Upper vent opening with a minimum opening of 310 cm^2 must be installed no lower than 185 cm above the floor.
- 2 Lower vent opening with a minimum opening of 155 cm^2 must be installed no more than one foot above the floor.

Ambient Temperature

- Temperature must be between $10 \text{ }^\circ\text{C}$ and $35 \text{ }^\circ\text{C}$.
- If the ambient temperature is too low or high, performance may be affected.
- Do not install in direct sunlight or where the temperature may fall below $0 \text{ }^\circ\text{C}$.

Electrical Connection

- Do not use an extension cord or double adapter.
- Do not overload the outlet with more than one appliance.
- Connect the appliance to an earthed socket in accordance with current wiring regulations.
- The appliance must be positioned a place close to outlet sockets so that the plug is easily accessible.

⚠ WARNING

- The power plug must be plugged into an appropriate outlet socket that is installed and grounded/earthed in accordance with all local codes and ordinances.

Unpacking the Appliance

⚠ WARNING

- Use two or more people to unpack and move the appliance. Failure to do so can result in serious injury by tipping the appliance.

Removing carton and shipping materials

Unpack the appliance from carton then remove any tapes and temporary labels from the appliance.

- Do not remove any warning labels, the model and serial number label, or the technical sheet label that is located under the front of the appliance.

⚠ CAUTION

- Do not use sharp instruments, rubbing alcohol, flammable fluids, or abrasive cleaners to remove tape or glue. These products can damage the surface of the appliance.

NOTE

- Tape or glue residue can also be easily removed by rubbing a small amount of liquid dish soap over the adhesive with your fingers. Wipe with warm water and dry.

Moving the Appliance

Use the wheels ❶ at the bottom of the appliance to move the appliance. Push the appliance slowly from about halfway down the front side.

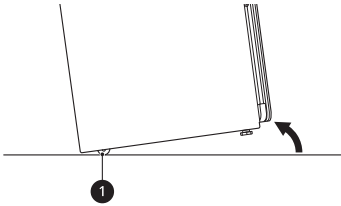

⚠ CAUTION

- Keep the appliance upright when moving it. If you lay the appliance on its side, refrigerant may leak and cause the appliance to malfunction.

Levelling the Appliance

Checking the Level

Levelling the appliance prevents unnecessary noise, vibration and movement. Check whether the appliance is perfectly level after installation.

Adjusting and Levelling the appliance

⚠ WARNING

- The appliance is heavy. Two or more people are required when levelling the appliance. Failure to follow this warning can cause serious injury or death.

1 Position the appliance in the final location and check to make sure it is level.

- All levelling feet must rest solidly on the floor. Gently push on the corners of the appliance to make sure that it does not rock from corner to corner. Make sure there are no gaps between the front levelling feet and the floor.

2 Use the wrench (packaged with the appliance) to turn the levelling feet.

- Unscrew the front feet to raise the appliance or screw in the feet to lower it. If unable to level the appliance using only the front feet, install the two rear levelling feet by tipping the appliance down to install the levelling feet.
- Raise or lower the appliance using the levelling feet until the appliance is level from side to side and front to back.

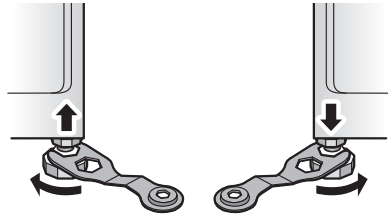

⚠ CAUTION

- Make sure that all levelling feet are in firm contact with the floor. If the appliance is used without levelling, it may fall, causing injury, damage, or product malfunction.
- Adjust the levelling feet only as far as necessary to level the appliance. Extending the levelling feet more than necessary can cause the appliance to vibrate.

3 When the appliance is completely stable and all levelling feet are resting solidly on the floor, tighten the locking nuts ❶.

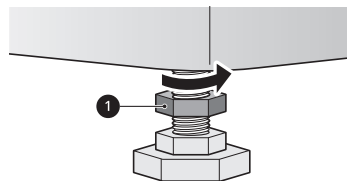

Reversing the door

It is possible to reverse the direction of the door swing. This should be done by the installer at the time of installation, if desired.

NOTE

- If the direction of the door swing needs to be changed after installation, contact the LG Customer Information Centre.
-

Using Anti-Slip Sheets

Anti-slip sheets prevent the appliance from shaking or shifting when opening or closing the door.

- 1 Clean the floor to attach the anti-slip sheets.
 - Use a dry rag to remove and clean foreign objects or moisture. If moisture remains, the anti-slip sheets may slip.

- 2 Adjust the level after placing the appliance in the installation area.

- 3 Place the adhesive side ❶ of the anti-slip sheets on the floor.

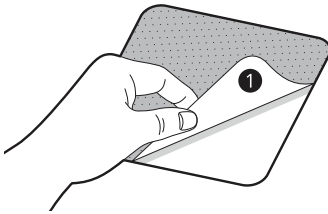

- 4 Put the appliance on the anti-slip sheets.
 - Do not attach the adhesive ❶ of anti-slip sheets to the feet of the appliance.

- 5 Recheck the appliance's levelness.
 - Push or rock the edges of the appliance gently to make sure that the appliance does not rock. If the appliance rocks, level the appliance again.

NOTE

- The pads may leave a sticky residue when they are removed. The residue can be removed with alcohol.
-

Installing the anti-tip device

Install the anti-tip device packed with the appliance to reduce the risk of tipping.

- Refer to the instructions provided with the anti-tip kit for proper anti-tip device installation.
- Do not operate the appliance without the anti-tip device in place and engaged.
- Check that the anti-tip device is properly installed. With the appliance in its final location, make sure that the slide adjuster on the cord is adjusted until there is about 2.5 cm of slack in the cord.
- If an anti-tip device is not properly installed, the appliance could be unexpectedly tipped by a child or adult standing, sitting, leaning, or placing excessive weight on an open door or the interior parts.
- The use of the anti-tip device does not preclude tipping of the appliance when it is not properly installed.

Assembling the drip tray

Before using the appliance, insert the drip tray onto the bottom of the cabinet.

- 1 Hold the tray so the arrow and letter on the front of the tray face up.

- 2 Insert one side of the tray first, then the other. Push the tray until it slides completely in.

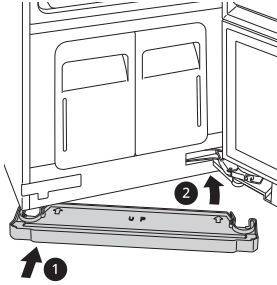

- 3 To detach, pull one side out then the other.
 - If the tray collects water, detach it and empty the water. After emptying it, reassemble the tray.

⚠ CAUTION

- Do not operate the appliance without installing the drip tray. Doing so could lead to water damage caused by leaking.

Installing hinge covers

- 1 Open the appliance door.
- 2 Snap the hinge cover onto the upper hinge assembly with the bent edge on the far side from the hinge.

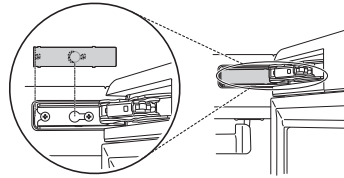

- 3 Repeat with the remaining hinge cover on the lower hinge assembly.

Installing cap covers

- 1 Line up the nubs on the cap cover with the holes in the top corner of the cabinet and then snap the cap cover into place.
- 2 Repeat with the remaining cap cover on the other corner.

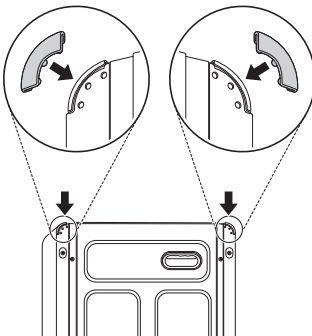

OPERATION

Operation Overview

Using the Appliance

1 Prepare items.

- Wash clothes first, if needed.
- No heat-sensitive items or items that can be damaged by exposure to water.
- Place items on hangers or the shelf.
- Fasten buttons and close zippers to keep items on moving hangers and prevent damage.

2 Clean the lint filter and change the sheet in the aroma filter.

- Lift out filter and remove lint from last load for faster and more efficient performance. Reinstall filter, checking alignment when closing grill. Do not operate the appliance without the lint filter in place. If using a fabric softener sheet in the aroma filter, change it after every use.

3 Check the water tanks.

- Fill water supply tank if needed. Empty water drain tank if needed. Use clean tap water in the supply tank for better product performance and lifespan. Do not use distilled water or reuse water from the drain tank.

4 Load the appliance.

- Pay attention to fabric care labels and programme choice. If clothing is not appropriate for the programme selected, it may shrink or be seriously damaged.
- Remove all empty hangers to avoid noise, friction, and damage to clothing.

5 Turn on the appliance.

- Touch **Power** button to turn on the appliance.

6 Choose a desired programme.

- Touch a programme selector button. You can toggle to one of the settings each time you pressed the button.

7 Begin a programme.

- Touch and hold **Start/Pause** button to begin a programme. Pause programme at any time by touching **Start/Pause** button again. If the **Start/Pause** button is not pressed within a certain time, the appliance will shut off and all settings will be lost.
- Do not open door during programme. If steam or hot air escapes from open door, condensation may collect on floor or walls, resulting in damage or mold.

CAUTION

- Do not open the door during operation. There is a risk of burns or injury from escaping hot air or steam.
- Do not allow steam or hot air to escape the cabinet during operation. Opening the door during operation also affects performance, lengthens styling time, and results in water condensing and collecting on the floor.

8 End of programme.

















- Remove items when programme finishes. Leave door open to let hot air escape. Interior light shuts off after 1.5 minutes if door is left open.

Preparing Loads

Checking the Fabric Care Labels

Most articles of clothing feature fabric care labels that include instructions for proper care. Below are some of the symbols that are relevant to choosing appropriate items for the appliance.

Symbols on the care labels

Label	Meaning	Check
	Hand Wash	OK
	Machine Wash, Normal cycle	OK
	Perm press/wrinkle resistant	OK
	Gentle/delicate	OK
	Do not wash	OK*1
	Normal	OK
	Permanent press/wrinkle resistant	OK
	Gentle/delicate	OK
	Do not tumble dry	OK
	Do not dry	NO
	Line/hang dry	OK
	Drip dry	OK
	Dry flat	OK
	High	OK
	Medium	OK
	Low	OK
	No heat/air dry	NO

*1 Some items such as fur and leather, which are labelled as do not wash, can be used with the appliance.

Sorting the items

- For best fabric care results, always treat fabrics with similar care requirements together.
- Different fabrics have different care requirements, and some fabrics cannot be treated in certain programmes or should be treated separately.

Checking the items before Loading

Some items are not appropriate for use with the appliance. Using the wrong programme for items can result in damage to fabrics.

- Check all pockets to make sure that they are empty. Items such as clips, pens, coins, and keys can damage both the appliance and your clothes.
- Do not put items that are sensitive to heat or are not suitable for washing with water in Styler programmes that use steam. Use the **Gentle Dry** programme only.
- Fur, leather (only 100% natural leather) should only be treated with the **Fur/Leather Care** programme. This programme is a downloadable programme.
- Wash heavily soiled or stained clothes before putting them in the appliance. The appliance does not have a washing function. Loose soil or stains can be transferred between garments during programmes.
- Treat items with an unpleasant odour in a separate load. Odours can be transferred between items during programmes.
- Clothing should be securely fastened, with zippers and buttons closed, so that it does not fall off the moving hanger during the programme.
- Do not put very wet items in the appliance to dry. Shake off or wring out excess water before putting items in the cabinet to dry. If a large amount of water pools in the cabinet, styling performance may suffer or the appliance may be damaged.

Checking the Items before Every Load

Checking the Lint Filter

Always make sure the lint filter is clean before starting a new load; a clogged lint filter will increase styling times.

- 1 Open the front grill ① and take out the lint filter ②.

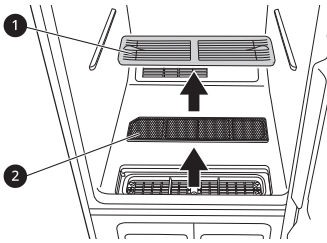

- 2 Brush the lint filter with a soft brush or clean it with a vacuum cleaner.
 - If the lint filter is torn or damaged, replace it with a new one.

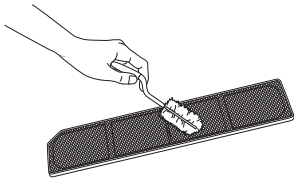

- 3 Reinstall the filter.

⚠ CAUTION

- Check that the sides are aligned correctly when inserting the front grill.



앞 / Front

Checking the Aroma Sheet

Use a dryer fabric softener sheet to add a refreshing aroma to items. Replace the fabric softener sheet after every use.

- 1 Remove the aroma filter from the appliance.

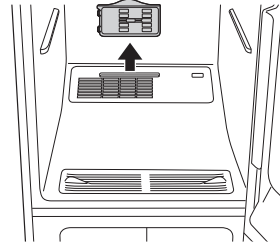

- 2 Open the aroma filter and insert a dryer fabric softener sheet ① into it.

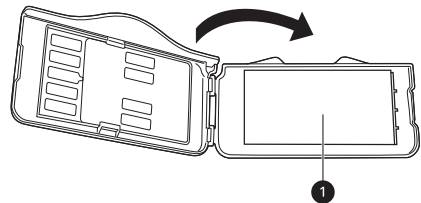

- 3 Close the aroma filter and insert it back in the appliance.
 - Insert the aroma filter in the direction of the arrow. You can adjust the opening of the aroma filter using the adjustment lever. The more open the aroma filter is, the richer the aroma gets.

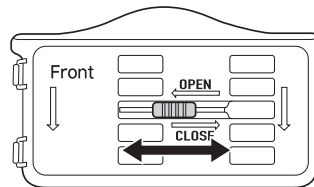

- 4 When the programme is complete, remove the aroma filter and discard the fabric softener sheet.

NOTE

- Spray perfume 4–5 times on a cotton pad and then place it in the Aroma Holder to use. (However, the fragrance strength can vary depending on the scent.)

- Use only clean tap water or bottled water. Foreign materials in the water may shorten the lifespan of the appliance.
- Do not use distilled water. The water sensor may not work.
- Do not reuse the water in the drain tank to fill the water supply tank.

Checking the Water tanks

Check the water in the water tanks before use. The water supply tank must be filled with water before using the appliance. The appliance does not work without water. The water drain tank should be emptied before each use.

- 1 Pull the handle of the tank forward and then take the tanks out of the appliance. Check water level of the tanks.

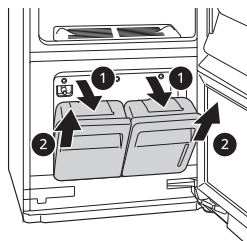

- 2 Make sure the water supply tank is filled with water.
 - The full water supply tank can be used approximately four times, depending on the programmes used.
 - Use clean tap water or bottled water for best performance and longer product life. Do not use distilled water or reuse the water from the drain tank.
 - The first time the appliance is used, 2/3 of the water in the fully filled water supply tank is used. Less water is used in following programmes.

- 3 Make sure the water drain tank is empty.
- 4 The drain tank will be filled after about three uses. The tank fills more quickly during styling programmes. The appliance does not work if the drain tank is full.
 - Some discolouration of the water drain tank may occur over time. This is normal and will not affect product performance.

Loading the Appliance**⚠ WARNING**

- Flammable objects such as lighters or matches could ignite, causing a fire. Remove them from pockets to avoid fire, explosion, or death.
- Never style clothes that have been exposed to oil, gasoline, or other flammable substances. Failure to obey this warning can result in fire, explosion, or death.

Choosing Styling method suitable for your items

Item	How to style it
Suit coat, blazer	Moving hanger
Coat, jacket (short)	
Coat (long)	
Dress (short)	Moving hanger after removing shelf
Dress (long)	

⚠ CAUTION

- Only use water when filling the water supply tank. Any other substance, such as detergent or fabric softener, may damage the appliance.

Item	How to style it
Skirt	Moving hanger
Lightweight blanket, throw	
Baby blanket	
Pants (not creased)	
Shorts	
Children's clothes	
Scarf	Moving hanger or shelf
Tie	
Shawl	
Lingerie	Moving hanger or shelf (if delicate)
Shirt, blouse	
Pants (creased)	Pants Crease Care
Cap, hat	Shelf
Stuffed toys	
Pillow	
Sweater	
Knitwear	
Infant clothes	

plastic or metal hanger that hooks snugly into the indentations in the moving hanger.

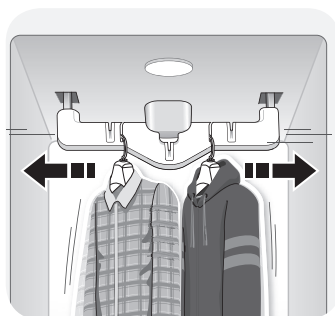

- Use the moving hanger for suits, coats, jackets, blouses, dresses, skirts, and pants that don't require a crease. Use the pants crease care to crease pants.
- Anything that can be securely placed on a hanger and steamed or dried without retaining hanger marks or other damage can be placed on the moving hanger.
- Style sweaters or knits on the shelf to avoid hanger marks.
- Arrange clothing so it does not touch the sides or rear of the cabinet, if possible. Condensation may form on the interior surface of the cabinet, and items in contact with the surface may remain damp at the end of the programme. Hang larger items on the diagonal indentations on the moving hanger.
- The moving hanger will move even when only the shelf is being used.
- When using an ordinary metal/plastic hanger, the hook is less than 4 mm thick and the hook must fit in the indentation in the moving hanger snugly. If the fit is too loose, it may result in vibration, noise and damage to clothing.

The Moving Hanger

Hang clothes on the moving hanger using the hangers provided with the appliance, or use any

⚠ CAUTION

- Remove empty hangers from the moving hanger and place them on the shelf before starting the programme. Empty hangers may cause unnecessary noise, friction, and damage to fabrics.
- Do not lean or pull on the moving hanger.

- Hang hangers in the same direction on the moving hanger to prevent collisions.
- Do not allow children to play with or hang onto the moving hanger. The appliance could tip, resulting in damage or injury.

Using the Moving Hanger

- 1 Insert hangers into slots and pull down to secure the hook snugly.
 - Hooks should fit down in the slots snugly to prevent noise, vibration, or damage to items during operation.
- 2 Use the diagonal slots (2, 4) for bulky items.
 - Do not use diagonal slots (2, 4) and standard slots (1, 3, 5) during the same programme. The hangers may knock into each other and damage clothing.

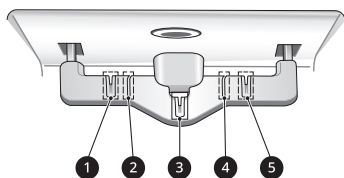

NOTE

- Do not overcrowd items. The fewer items, the better the styling performance. Items that touch the sides of the cabinet may pick up condensation from the cabinet and fail to style completely.

How to use Hangers

The hangers that come with the appliance are for use with the appliance only. Any plastic or metal hanger that has a hook less than 4 mm thick and hooks snugly into the indentations in the moving hanger can be used in the appliance.

- Do not use hangers with wool, knitwear, or delicate lingerie. The garments may stretch or be left with hanger marks.

- Wrinkles may appear at the back of the collar on some garments.
- Use the diagonal hanger grooves in the moving hanger for large or bulky items.
- Remove empty hangers or store them in the shelf during operation.
- Fasten buttons and zippers on hanging clothes to prevent them from falling off hangers during operation. Fasten the neck area with cotton string if there is no button or zipper.
- Remove or store the shelf when hanging longer items so items won't get wrinkled.

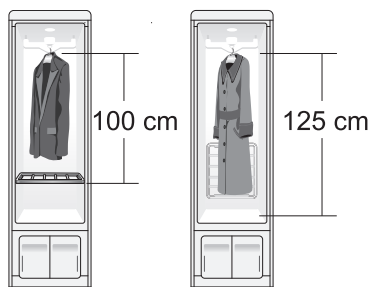

- 1 Select an appropriate hanger.
 - Choose the appliance hanger that fits the item you are hanging up.
- 2 Fasten the buttons and zippers on all garments and hang them on hangers.
 - Doing so helps keep the garments from falling or becoming more wrinkled during the programme. If a garment has no buttons or zipper, fasten it with a cotton string around the collar area.



- 3** Place the hangers into the slots of the moving hanger.

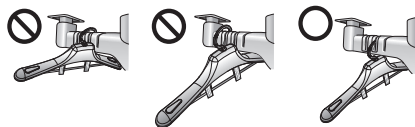

The Pants Hanger

Place pants either on the moving hanger or in the pants crease care, depending on whether maintaining the creases on the pants legs is desired.

NOTE

- Hanging pants on the moving hanger may reduce the creases on pants legs. To maintain the creases on pants legs, use the pants crease care.
- Pants should be no wider than 96 cm or longer than 110 cm to fit in the pants crease care. Check the size of the pants before using the pants crease care. If pants are too large, use the moving hanger.
- The fabric content of the garments affects how well wrinkles are reduced.
- For optimum results, use the extra pants care programme which is designed for use with the pants crease care feature. This programme can be downloaded using the **LG ThinQ** and used as the Downloaded programme.

Opening and Closing the Pants Hanger

- 1** To open, fold the hook down toward the hanger blades to unlock and separate the blades.

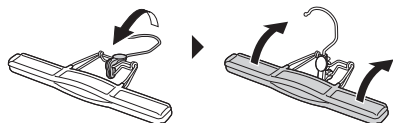

- 2** Once pants are inserted, bring the blades together and rotate the hook up and away from the blades to lock them in place.

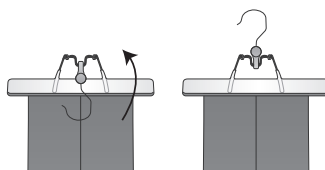

Hanging Pants On the Pants Hanger

- 1** Remove all objects from pants pockets and button the back pockets.
- 2** Fold pants along crease lines (or where crease lines would be), and attach the pants hanger at the ends of the pants legs.

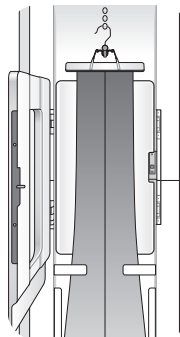

- 3** Tug gently on the sides of the pants legs. Make sure pants are stretched tight within the hanger, with no wrinkles, and will not fall out of the hanger during the programme.

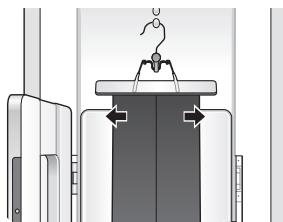

- 4 Place the pants hanger on the moving hanger or in the pants crease care.



- To avoid double creases, run the strong course with the moving hanger to remove any existing knife pleats, and then use the pants press.



The Pants Crease Care

Hang clothes in the pants crease care using the pants hanger provided with the appliance or any pants hanger that fits into the hooks above the door to the pants crease care.

⚠ CAUTION

- Do not lean on or hang heavy items on the door of the pants crease care. The appliance may tip, resulting in damage or injury.
- Do not allow children to play with or hang onto the door of the pants crease care. The appliance may tip, resulting in damage or injury.
- Keep fingers out of pinch point areas when closing the door of the pants crease care. Supervise nearby children to prevent injuries.

NOTE

- Pants can be pressed while refreshing other items in the same programme.

- For optimum results, use the extra pants care programme which is designed for use with the pants crease care feature. This programme can be downloaded using the **LG ThinQ** and used as the Downloaded programme.

- 1 Open the pants crease care by pressing on the icon on the side.

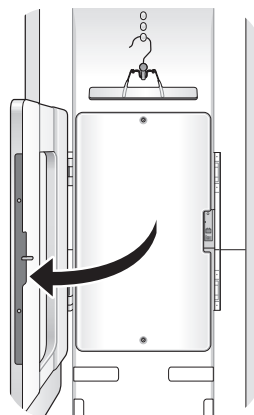

- 2 Hang the pants hanger on the hook above the pants crease care that best fits the length of the pants being pressed.

26 OPERATION

- If the pants are longer, use the higher hooks **1** to keep the pants from hitting the floor of the cabinet.

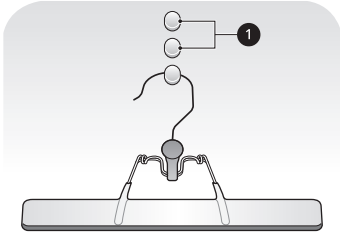

- Pants should be no wider than 96 cm or longer than 110 cm. Check the size of the pants before using the pants crease care. If pants are too large, use the moving hanger.

3 Make sure the pants are hanging straight.

- Check the creases on the legs to make sure they are lined up. Fix the pants with 2 clips before closing the pants crease care. If the pants legs are not aligned properly or the pants are not hanging straight, double lines may appear at the pants' edges, or the pants may be wrinkled.

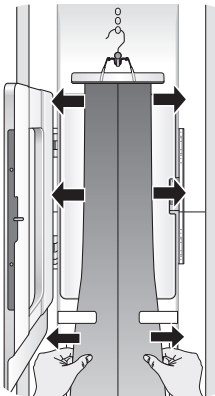

4 Close the pants crease care, then straighten the pants once more.

- Gently tug the edges of the pants to smooth out any wrinkles. Make sure the pants are hanging straight in the pants crease care.

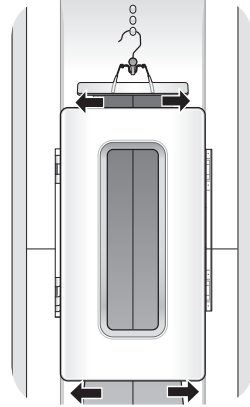

The Shelf

Use the shelf when styling clothes or other items that are difficult to hang or that may be damaged by hang styling.

⚠ CAUTION

- Do not allow children to climb on or hang on the shelf. The shelf may fall or the appliance may tip, resulting in damage or injury.
- Do not place heavy objects on the shelf or use it to store objects. The shelf may fall, resulting in damage or injury.

NOTE

- Use the shelf for sweaters, knits, lingerie, or delicate blouses that can show hanger marks, stretching, or other damage if dried on a hanger.
- For best styling performance, do not stack items on the shelf. Style single items or place items side by side with space between.
- When not in use, store the shelf on the shelf holder knobs in the back of the cabinet.
- Arrange items on the shelf so they do not touch the sides or rear of the cabinet, if possible. Condensation may form on the interior surface

of the cabinet, and items in contact with the surface may remain damp at the end of the programme.

Assembling the Shelf

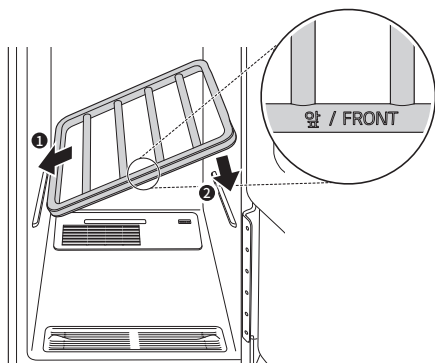

- 1 Hold the shelf so that the grey trim is toward the front.
- 2 Insert the left shelf groove into the left shelf support, then lower the right shelf groove onto the right shelf support.

NOTE

- The shelf cannot be assembled by sliding it into the cabinet. It will fall if not assembled properly.

- 3 To disassemble, lift up the right side of the shelf, then pull out the left side of the shelf from the shelf support.

NOTE

- Hang the shelf on the shelf holder when treating long clothes such as coats or dresses.

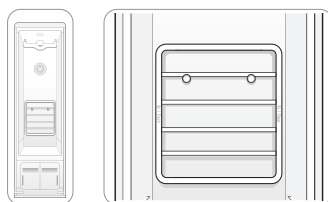

Storing Hangers

Remove unused hangers from the moving hanger and store them in the shelf during operation. This prevents noise and damage to clothing.

- 1 Insert the hangers between the rails of the shelf.

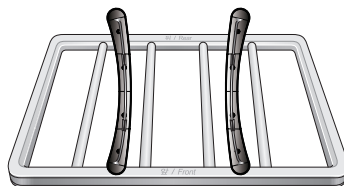

- 2 When styling long clothes, if the shelf is stored on the shelf holder, store the hangers outside the appliance during operation.
- 3 Do not use the shelf to store heavy items.



Control Panel

The control panel responds to touch using static electricity. A light touch is enough to operate it. Use a cloth when cleaning the controls to avoid contacting and activating the buttons. Foreign substances on the control, wearing gloves, or touching the buttons through cloth may prevent the buttons from activating.

Control Panel Features

Depending on the model, some of the following functions may not be available.

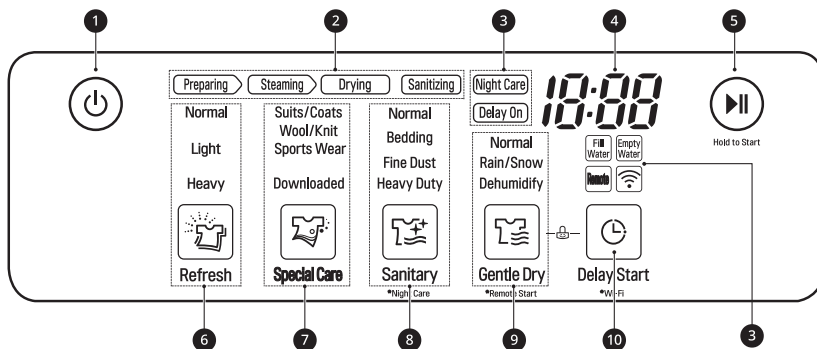

1 Power Button

Touch **Power** button to turn the appliance On/Off. Once the programme is complete, the appliance automatically turns off after a few seconds if no buttons are touched.

NOTE

- Touching **Power** button during a programme will cancel that programme and the programme settings will be lost.

2 Programme Process Indicator

This portion of the display shows which stage of the styling programme is currently underway.

3 Option and Alert Indicators

- **Night Care** lights up to when the appliance is in the **Night Care** mode.
- **Delay On** lights up when the **Delay Start** feature is set.
- **Fill Water** lights up when the water supply tank is missing or empty.
- **Empty Water** lights up when the water drain tank is missing or full.
- **Remote** lights up when the appliance can be controlled remotely.
- : lights up when the appliance is connected to Wi-Fi network at home.

4 LCD Display

The display shows the estimated time remaining and error messages for the appliance. The programme time may vary by usage conditions.

5 Start/Pause Button

Touch and hold to start the selected programme. If the appliance is running, touch to pause the programme without losing the current settings.

NOTE

- If you do not touch **Start/Pause** button to resume a programme within an hour of pausing it, the appliance turns off automatically.
-

6 Refresh Programme

Touch this button to select a **Refresh** programme. You can toggle to one of the settings when you touch the button repeatedly.

7 Special Care Programme

Touch this button to select a **Special Care** programme. You can toggle to one of the settings when you touch the button repeatedly.

NOTE

- When you toggle to the **Downloaded** setting, you can use 5 special programmes which are set as default on your appliance. It allows you to download a new special programme using **LG ThinQ** application on a smartphone.
-

8 Sanitary Programme

Touch the button to select a **Sanitary** programme. You can toggle to one of the settings when you touch the button repeatedly.

Night Care

- Touch and hold the **Sanitary** button for 3 seconds to activate/deactivate the **Night Care** function.

9 Gentle Dry Programme

Touch the button to select a **Gentle Dry** programme. You can toggle to one of the settings when you touch the button repeatedly.

Remote Start

- With the **LG ThinQ** app, you can use a smartphone to control your appliance remotely.
- In order to use the Remote Start function, refer to **SMART FUNCTIONS**.

10 Delay Start

Touch this button to delay the start time of the programme.

Wi-Fi

- Touch and hold this button for 3 seconds to initiate the connection of the appliance to the **LG ThinQ** application.

Programme Table

The programmes are designed to fit a variety of situations. Select the programme and setting that best match the load contents and desired results for maximum performance and fabric care.

Styling Programme Guide

Programme	Refresh
Setting	Normal / Light / Heavy Refresh your clothes with high temperature steam and vibration. The programme helps you to reduce odours and wrinkles of the clothes.
Fabric / Clothes	Suit, coat, school uniform, scarf, wool, knitwear, outdoor/performance clothing, towels, underwear, t-shirts, socks, jeans, jean jackets, lingerie, sportswear, tablecloths
Note	<ul style="list-style-type: none"> • Only washable items are allowed to use this programme because the appliance sprays steam to the clothes. • The appliance smooth out the wrinkles by spraying steam to the clothes. The wrinkles may remain on the clothes after styling. Iron the clothes, if desired. • The wrinkles care performance depends on the weight and fabric of the clothes.

Programme	Special Care
Setting	Suits/Coats: Refresh the clothes with low temperature steam and vibration. The setting helps you to care the suits and coats that contains natural fibers.
	Wool/Knit: Specially designed to relieve wrinkles from wool and knit.
	Sports Wear: Use to protect fabric for sports wear.
	<p>Downloaded: There are 5 special programmes which are set as a default. You can choose one of special programmes each time the Special Care button is touched.</p> <ul style="list-style-type: none"> • With LG ThinQ application, you can see what a special programme is selected and download a new special programme.

Programme	Sanitary
Setting	Normal / Bedding / Fine Dust / Heavy Duty Use this programme to reduce germs and to dry items. Choose this programme for clothing, bedding, and children's clothing and soft toys. Quilts or blankets should be a single layer and weigh 1.5 kg or less.
Fabric / Clothes	Suit, coat, school uniform, scarf, outdoor/performance clothing, towels, underwear, t-shirts, socks, jeans, jean jackets, lingerie, sportswear, tablecloths

Programme	Sanitary
Note	<ul style="list-style-type: none"> Do not use this programme for wool or knitwear, because the high temperatures and steam can cause shrinkage. Natural fibers must be marked washable/hand-washable and tumble dry, to avoid shrinkage. Do not use with items containing rubber, foam, or adhesive.

Programme	Gentle Dry
Setting	Normal: Dry clothes using warm air and moving hanger without tumbling. It is suitable for refreshing non-washable fabrics and natural fibers like 100% wool, cashmere.
	Rain/Snow: Use this setting to dry damp clothes.
	Dehumidify: Use this setting to dehumidify the room where the appliance is installed. Use while door is open 45°. If door is closed, the setting does not operate.
Note	<ul style="list-style-type: none"> The wrinkles care performance depends on the weight and fabric of the clothes.

NOTE

- Check **Fabric Care Guide** in this manual and fabric care labels on garment before styling.
- Wrinkles may remain in some items. Wrinkles caused by extended storage may be difficult to reduce. Wrinkles in cotton or linen may not be reduced completely. Iron after styling, if desired.
- Some odours can be difficult to remove. Odours from oily substances may be difficult for the steam to penetrate. Odours from extended storage may also be difficult to remove.
- Programme times may vary depending on the usage environment, including water temperature.
- Very thick clothing may not be dried uniformly at the end of the programme.
- Styling times for the programme may be longer for wet clothes that are not spin dried.

Wrinkle Care

The appliance utilizes high temperature steam and moving hangers to reduce wrinkles without damaging the garment.

Wrinkle Care Performance Comparison Styler

The appliance uses steam to indirectly ironing, wrinkled clothing may not be fully stretched. At this time, there may be a difference in wrinkle care performance with depending on the weight and material of the cloth.



	Wrinkle Reduction Level
①	Styler
A	Before ironing
B	Steam iron
C	Press iron

Process Details for Each Styling Programme

- **Preparing:** This process heats the water in the water tank in preparing for supplying steam.
- **Steaming:** This process sprays steam on the clothes.
- **Drying:** This process removes moisture in the clothes.
- **Sanitizing:** This process removes germs from the clothes.

Programme		Styling Process			
Programme	Setting	Preparing	Steaming	Drying	Sanitizing
Refresh	Normal	●	●	●	
	Light	●	●	●	
	Heavy	●	●	●	
Special Care	Suits/Coats	●	●	●	
	Wool/Knit	●	●	●	
	Sports Wear	●	●	●	
	Downloaded				
Sanitary	Normal	●	●	●	●
	Bedding	●	●	●	●
	Fine Dust	●	●	●	●
	Heavy Duty	●	●	●	●
Gentle Dry	Normal			●	
	Rain/Snow	●	●	●	
	Dehumidify			●	

NOTE

- If the **Sanitary** programme are changed to a kind of **Refresh** or **Gentle Dry** programme during operation, the sanitize process is not performed.

Fabric Care Guide

Fabric & Clothes	Programme			
	Refresh		Sanitary	Gentle Dry
	Wrinkles	Odours		
Cotton Towels, socks, underwear, jeans, sportswear, T-shirts, blankets		●	●	●
Linen, hemp, ramie Summer clothes, tablecloths		●	●	●
Alpaca, camel hair, cashmere Coats, suits	●*1	●*1	●*1	●*1
Scarves, knitwear		●*1		●
Fur, leather Coats, scarves	<ul style="list-style-type: none"> • Style the fur, leather clothes using a special programme, which is downloadable from LG ThinQ application. But leather is only 100% natural leather (No artificial leather) 			
Silk Neckties, ribbons, scarves, blouses, silk velvet/plush	<ul style="list-style-type: none"> • Only use downloaded Silk Care cycle (low temperature drying). 			
Wool Sweaters, knitwear		●*1		●
Winter coats, suits, sportswear, uniforms	●	●	●	●
Acetate Suit lining, blouses, neckties, pajamas	●	●	●	●
Acrylic Suit lining, blouses, neckties, pajamas	●	●	●	●
Nylon Stockings, lingerie	●	●	●	●
Polyurethane (less than 5%) Stretchable clothing	●	●	●	●

Fabric & Clothes	Programme			
	Refresh		Sanitary	Gentle Dry
	Wrinkles	Odours		
Rayon Suit Lining	●	●	●	●

*1 Check fabric care labels in garments before use.

NOTE

- Fabrics come in a wide variety of weights and finishes and can have different care requirements for each variety. It is difficult to cover them adequately in this manual. Before using the appliance with any item, check the care label before proceeding.
- Do not put items that are not colour fast, are heat-sensitive, or are not suitable for washing with water in the **Refresh** or **Sanitary** programmes. Do a water blot test on a small, inconspicuous spot (an inside seam) to determine if the fabric is colour fast. For further assistance, consult the clothing manufacturer, a dry cleaning professional, or a more detailed fabric care guide.
- Using the appliance with items that are very wet or are not colourfast may result in damage to the items and staining from fabric dyes on the interior of the cabinet. These stains will not affect the operation of the appliance. Use toothpaste to remove stains from interior of cabinet.
- The appliance does not have a washing function. Wash soiled items before use.

Option Programmes and Extra Functions

- Once set, the function remains active until it is manually deactivated. The function must be deactivated to run another programme.

Child Lock

Use this function to prevent unwanted use of the appliance or to keep programme settings from being changed while the appliance is operating.

- 1 Touch and hold the **Gentle Dry** and **Delay Start** buttons for 3 seconds to activate or deactivate the control lock function.
- 2 \square L appears on the LCD display, and all controls are disabled except the **Power** button.

NOTE

- The function does not lock the door.
- The function is retained even if there is a power outage.

Delay Start

Use this function to delay the start time of the programme.

- 1 Touch **Power** button.
- 2 Choose a programme and setting.
- 3 Touch **Delay Start** button to set the start time of the programme.
 - The default delay time is 3 hours. Each time you touch the button, the time increases by an hour, up to 19 hours.
 - Touch and hold the button to increase the delay time more quickly.

NOTE

- This option cannot be selected when the appliance is in the **Night Care** mode.
-

Night Care

Use this function to store items overnight or anytime, items can't be removed soon after a programme ends. The function periodically produces warm air to prevent condensation, keeping items warm and dry until they are removed.

- 1 Place clothes into the appliance.
- 2 Choose a programme and setting.
- 3 Touch and hold **Sanitary** for 3 seconds to activate the **Night Care** function.
- 4 Touch **Start/Pause**.

NOTE

- Once set, the function starts after the selected programme ends. To cancel the function, touch another programme button.
 - The function can't be set to follow a **Gentle Dry** programme.
 - The settings are lost if you touch **Power** button.
 - The function runs for a maximum of 24 hours.
 - It is safe to open the door at any time during the function, even when the air is blowing.
 - Some noise occurs periodically to produce warm air.
-

Dehumidify

Dehumidifies the room where the appliance is installed. Room dehumidifying time can be set to 2 or 4 hours by touching the **Gentle Dry** button.

Notification icon will be displayed with alarm if drain tank is full. Empty drain tank and touch **Start/Pause** button to continue dehumidification.

- The **Night Care** feature cannot be used while using **Dehumidify** setting.
- Use while door is open 45°. If door is closed, the course does not operate.
- The drain tank may be filled before end of **Dehumidify** setting depending on the environment.
- It is possible for room temperature to increase due to outgoing airflow from the appliance.

SMART FUNCTIONS

LG ThinQ Application

The **LG ThinQ** application allows you to communicate with the appliance using a smartphone.

LG ThinQ Application Features

Communicate with the appliance from a smartphone using the convenient smart features.

Push Alerts

When the programme is complete or the appliance has problems, you have the option of receiving push notifications on a smartphone. The notifications are triggered even if the **LG ThinQ** application is off.

Smart Diagnosis

This function provides useful information for diagnosing and solving issues with the appliance based on the pattern of use.

Energy Monitoring

This function checks the energy consumption of the recently used programme and monthly average.

Settings

Allows you to set various options on the appliance and in the application.

NOTE

- If you change your wireless router, Internet service provider, or password, delete the registered appliance from the **LG ThinQ** application and register it again.
- The application is subject to change for appliance improvement purposes without notice to users.
- Functions may vary by model.

Before Using LG ThinQ Application

- 1 Check the distance between the appliance and the wireless router (Wi-Fi network).
 - If the distance between the appliance and the wireless router is too far, the signal strength becomes weak. It may take a long time to register or installation may fail.

- 2 Turn off the **Mobile data** or **Cellular Data** on your smartphone.

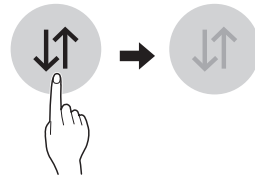

- 3 Connect your smartphone to the wireless router.

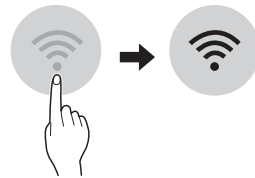

NOTE

- To verify the Wi-Fi connection, check that **Wi-Fi** or  icon on the control panel is lit.
- The appliance supports 2.4 GHz Wi-Fi networks only. To check your network frequency, contact your Internet service provider or refer to your wireless router manual.
- **LG ThinQ** is not responsible for any network connection problems or any faults, malfunctions, or errors caused by network connection.
- If the appliance is having trouble connecting to the Wi-Fi network, it may be too far from the router. Purchase a Wi-Fi repeater (range extender) to improve the Wi-Fi signal strength.

- The Wi-Fi connection may not connect or may be interrupted because of the home network environment.
- The network connection may not work properly depending on the Internet service provider.
- The surrounding wireless environment can make the wireless network service run slowly.
- The appliance cannot be registered due to problems with the wireless signal transmission. Unplug the appliance and wait about a minute before trying again.
- If the firewall on your wireless router is enabled, disable the firewall or add an exception to it.
- The wireless network name (SSID) should be a combination of English letters and numbers. (Do not use special characters.)
- Smartphone user interface (UI) may vary depending on the mobile operating system (OS) and the manufacturer.
- If the security protocol of the router is set to **WEP**, you may fail to set up the network. Please change it to other security protocols (**WPA2** is recommended) and register the product again.

Installing the LG ThinQ Application

Search for the **LG ThinQ** application from the Google Play Store or Apple App Store on a smartphone. Follow instructions to download and install the application.

Using the Appliance Remotely

Remote Start

Use a smartphone to control your appliance remotely. You can also monitor your programme operation so you know how much time is left in the programme.

Using this function

- 1 Put the clothes into the appliance.
- 2 Touch the **Power** button.

- 3 Touch and hold the **Gentle Dry** button for 3 seconds to enable the remote control function.
- 4 Start a programme from the **LG ThinQ** application on your smartphone.

NOTE

- Once this function is enabled, you can only start a programme from the **LG ThinQ** smartphone application. If the programme is not started, the appliance will wait to start the programme until it is turned off remotely from the application or this function is disabled.
- If the door has been opened, you can not start a programme remotely.

Disable this function manually

When the function is activated, press and hold the **Refresh** button for 3 seconds.

Download programme

Download new and special cycles that are not included in the basic cycles on the appliance.

Appliances that have been successfully registered can download a variety of specialty cycles specific to the appliance.

Once cycle download is completed in the appliance, the appliance keeps the downloaded cycle until a new cycle is downloaded.

To operate a downloaded programme on the appliance, touch the **Special Care** button on the appliance repeatedly until the **Downloaded** setting is lit up.

NOTE

- Only one downloaded programme can be stored on the appliance at a time.



Open Source Software Notice Information

To obtain the source code under GPL, LGPL, MPL, and other open source licenses, that is contained in this product, please visit <http://opensource.lge.com>.

In addition to the source code, all referred license terms, warranty disclaimers and copyright notices are available for download.

LG Electronics will also provide open source code to you on CD-ROM for a charge covering the cost of performing such distribution (such as the cost of media, shipping, and handling) upon email request to opensource@lge.com. This offer is valid for a period of three years after our last shipment of this product. This offer is valid to anyone in receipt of this information.

Smart Diagnosis

This feature is only available on models with the  or .

Use this feature to help you diagnose and solve problems with your appliance.

NOTE

- For reasons not attributable to LGE's negligence, the service may not operate due to external factors such as, but not limited to, Wi-Fi unavailability, Wi-Fi disconnection, local app store policy, or app unavailability.
- The feature may be subject to change without prior notice and may have a different form depending on where you are located.

Using LG ThinQ to Diagnose Issues



If you experience a problem with your Wi-Fi equipped appliance, it can transmit troubleshooting data to a smartphone using the **LG ThinQ** application.

- Launch the **LG ThinQ** application and select the **Smart Diagnosis** feature in the menu. Follow the instructions provided in the **LG ThinQ** application.

Using Audible Diagnosis to Diagnose Issues

Follow the instructions below to use the audible diagnosis method.

- Launch the **LG ThinQ** application and select the **Smart Diagnosis** feature in the menu. Follow the instructions for audible diagnosis provided in the **LG ThinQ** application.

- 1 Touch the **Power** button to turn the appliance on.
 - Do not touch any other buttons or icons on the display screen.
- 2 Place the mouthpiece of your smartphone close to the  or  logo.

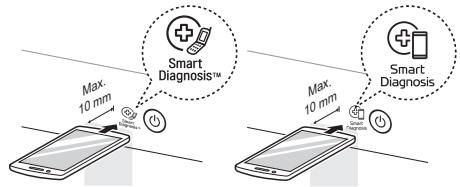

- 3 Touch and hold the **Sanitary** and **Gentle Dry** buttons for 3 seconds or longer while holding the smartphone mouthpiece to the logo until the data transfer is complete.
 - Keep the smartphone in place until the data transfer has finished. Time remaining for data transfer is displayed.
- 4 After the data transfer is complete, the diagnosis will be displayed in the application.

NOTE

- For best results, do not move the smartphone while the tones are being transmitted.

MAINTENANCE

⚠ WARNING

- Unplug the appliance before cleaning to avoid the risk of electric shock. Failure to follow this warning can cause serious injury, fire, electrical shock, or death.
- Never use harsh chemicals, abrasive cleaners, or solvents to clean the appliance. They will damage the finish.

Regular Cleaning

Cleaning the Interior and Exterior

Proper care of your appliance can extend its life.

- 1 Clean the inside and outside of the appliance with a damp cloth.
 - Glass cleaner can be used to clean the front glass panel, but spray it on a cloth and wipe rather than spraying it directly on the panel.
- 2 Buff the door dry with a clean, dry cloth to prevent any water stains.
- 3 Allow the interior and exterior to dry completely before plugging in and operating the appliance.

⚠ CAUTION

- Do not spray water directly on the appliance.
- Do not use detergent, methylated spirits, solvents, or any volatile liquids to clean the exterior of the appliance.
- Never use steel wool or abrasive cleansers; they can damage the surface.
- Keep sharp objects away from the exterior of the appliance. The touch panel may not work if damaged.

Cleaning the Lint Filter

Always remove the lint from the filter after every programme. If the lint filter has become very dirty or clogged, wash the lint filter in warm, soapy water and allow to dry thoroughly before reinstalling.

- Never operate the appliance without the lint filter.
- Never operate the appliance with a wet lint filter.

Cleaning the Aroma Filter

For best results, wash the aroma filter using hot water and dish soap. After cleaning, wipe the filter with a clean cloth and allow it to dry thoroughly before reinstalling it.

The aroma filter can also be cleaned in the top rack of the dishwasher.

- Never operate the appliance without the aroma filter.
- Never operate the appliance with a wet aroma filter.

Cleaning the Water Tanks

The water in the water supply tank contacts the clothing and items treated in the appliance directly. Clean both tanks periodically and keep them clean at all times. If the tanks are not properly cleaned, they may start to smell or need to be replaced.

- Some discolouration of the water drain tank may occur over time. This is normal and will not affect product performance.

40 MAINTENANCE

- Use only clean tap water in the supply tank for best performance and to prolong the life of the appliance. Do not use distilled water.
- Do not reuse the water from the water drain tank in the water supply tank.

1 Clean the exterior of the tanks with a wet cloth.

2 Please clean the inside of the water tanks with water by using a brush cleaning the water tanks.



3 Make sure the drainage nozzle **1** connected to the water drain tank and the water supply hole **2** connected to the water supply tank are not clogged.

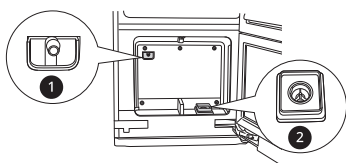

4 Allow the outsides of the tanks to dry completely before reinstalling the tanks.

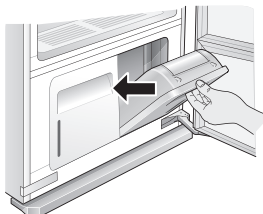

TROUBLESHOOTING

Operation of your appliance can lead to errors and malfunctions. The following tables contain possible causes and notes for resolving an error message or malfunction. It is recommended to read the tables carefully below in order to save your time and money that may cost for calling to LG Electronics service centre.

Before Calling for Service

Your appliance is equipped with an automatic error-monitoring system to detect and diagnose problems at an early stage. If your appliance does not function properly or does not function at all, check the following before you call for service.

Error Messages

Symptoms	Possible Cause & Solution
Fill Water icon is blinking.	Water supply tank is empty or tank is missing. <ul style="list-style-type: none"> Fill the water supply tank and reinstall it.
Empty Water icon is blinking.	Water drain tank is full or tank is missing. <ul style="list-style-type: none"> Empty the water drain tank and reinstall it.
dE error message shows on the display.	Door is not completely closed. <ul style="list-style-type: none"> Check that items are completely inside the cabinet and that the door is tightly closed.
RE, LE, LE2, E I, E4, E E I, E E2, E E3 or E E5 error message shows on the display.	System error. <ul style="list-style-type: none"> Unplug the appliance and call for service.

Operation

Symptoms	Possible Cause & Solution
The appliance won't operate.	Control panel has powered off due to inactivity. <ul style="list-style-type: none"> This is normal. Touch the Power button to turn the appliance on.
	Cord is unplugged. <ul style="list-style-type: none"> Make sure cord is plugged securely into a working outlet.
	Circuit breaker/fuse is tripped/blown. <ul style="list-style-type: none"> Check house circuit breakers/fuses. Replace fuses or reset breaker. The appliance should be on a dedicated branch circuit.
	Appliance is not connected to 220-240 V socket. <ul style="list-style-type: none"> Make sure the cord is plugged into a grounded socket rated for this appliance.
The programme won't start.	Start/Pause button was not touched after the programme was set. <ul style="list-style-type: none"> Touch Start/Pause button.
	Programme is producing steam. <ul style="list-style-type: none"> There may be a period of inactivity while steam is produced.
	Control panel is locked. <ul style="list-style-type: none"> Disable the locking of the control panel and touch Start/Pause button.
Smoke comes out when the door is opened.	Door is opened during operation. <ul style="list-style-type: none"> It is normal for steam or hot air to escape if the door is opened during operation.
Full water supply tank is empty after just one use.	Appliance is being used for the first time. <ul style="list-style-type: none"> A larger amount of water is needed the first time the appliance is used to fill the empty reservoir.
Appliance makes a loud vibrating noise on startup.	Moving hanger is balancing load before operation. <ul style="list-style-type: none"> This is normal at the beginning of the programme. If the noise increases or continues for a long time, call for service.
Styling times are taking longer than estimated.	Clothes were extremely wet when loaded. <ul style="list-style-type: none"> Styling times may be longer for very wet or bulky clothing. Dry damp clothes before putting them in the appliance. The appliance stops automatically when clothes are dry.
Appliance is moving from left to right while operating.	Floor under appliance is not level or is not sturdy enough to support the weight of the appliance without flexing. <ul style="list-style-type: none"> Install the appliance where the floor is level and sturdy. Compensate for any slight unevenness in the floor with the levelling legs.
Sound of motor whirring.	Compressor is running during styling. <ul style="list-style-type: none"> This is normal.

Symptoms	Possible Cause & Solution
Sound of water running, boiling, or hissing.	<p>Steam is being generated and sprayed onto clothes.</p> <ul style="list-style-type: none"> This is normal.
Steam or hot air leaks out when the door is closed.	<p>An item is caught in the door, keeping it slightly open.</p> <ul style="list-style-type: none"> Make sure all items are completely inside the cabinet and nothing is caught in the door, blocking it from closing completely.
Control panel won't respond.	<p>Control panel or button has dirt on it.</p> <ul style="list-style-type: none"> Dirt or foreign objects on the control panel will interfere with the operation of the buttons. Clean the control panel.
	<p>Control panel is locked.</p> <ul style="list-style-type: none"> Disable the locking of the control panel.

Performance

Symptoms	Possible Cause & Solution
Clothes are wet at the end of the programme.	<p>Filter is clogged or grill is upside down.</p> <ul style="list-style-type: none"> Clean the lint filter. Insert the grill with the holes on the right side.
	<p>Door gasket is damaged.</p> <ul style="list-style-type: none"> If the rubber door gasket is damaged, it leaves a gap in the door seal, affecting performance of the appliance. Call for service.
	<p>Clothes are caught in door.</p> <ul style="list-style-type: none"> Make sure all items are completely in the cabinet and not stuck in the door, blocking it from closing completely. Run the programme again.
Odour is not removed at end of programme.	<p>Clothes were stored for a long period of time or are stained with a strong-smelling substance.</p> <ul style="list-style-type: none"> Odours can be particularly difficult to remove from clothes that have been stored for long periods or have strong-smelling, oily stains. Wash the clothes first, before using the appliance.
Wrinkles are not reduced at end of programme.	<p>Clothes were stored for a long period of time.</p> <ul style="list-style-type: none"> Wrinkles may be very difficult to reduce if set for a long time, especially in cotton and linen fabrics. Iron clothes that have been stored for a long period of time before treating them with the appliance, to reduce wrinkles more effectively.
Clothes have an unpleasant odour at end of programme.	<p>Appliance has not been used for a long time or water tanks and filters have not been cleaned.</p> <ul style="list-style-type: none"> Check for dirt or foreign objects in the water supply and water drain tanks. Clean the filters and water tanks.
Functions are not operating properly.	<p>Detergent or fabric softener put in water supply tank.</p> <ul style="list-style-type: none"> Do not use anything but clean water in the water supply tank.

Symptoms	Possible Cause & Solution
Wrinkles at back of neck after programme.	<p>Item too large for hanger or fabric too delicate.</p> <ul style="list-style-type: none"> Use the right size hanger for the item so the fabric won't bunch up and cause wrinkles. Some fabrics are delicate and will bunch around the hanger no matter what you do. Use the shelf for lingerie and other delicate items.
Creases are gone from pants after programme.	<p>Pants were hung on the moving hanger, not in the pants press.</p> <ul style="list-style-type: none"> Hang pants in the pants press to maintain creases at edge of pants legs.
Clothing has water spots after programme, colour has faded or run.	<p>Fabric is not washable, or is not colourfast.</p> <ul style="list-style-type: none"> Check fabric care labels before treating items.

Wi-Fi

Symptoms	Possible Cause & Solution
Your home appliance and smartphone is not connected to the Wi-Fi network.	<p>The password for the Wi-Fi that you are trying to connect to is incorrect.</p> <ul style="list-style-type: none"> Find the Wi-Fi network connected to your smartphone and remove it, then register your appliance on LG ThinQ.
	<p>Mobile data for your smartphone is turned on.</p> <ul style="list-style-type: none"> Turn off the Mobile data of your smartphone and register the appliance using the Wi-Fi network.
	<p>The wireless network name (SSID) is set incorrectly.</p> <ul style="list-style-type: none"> The wireless network name (SSID) should be a combination of English letters and numbers. (Do not use special characters.)
	<p>The router frequency is not 2.4 GHz.</p> <ul style="list-style-type: none"> Only a 2.4 GHz router frequency is supported. Set the wireless router to 2.4 GHz and connect the appliance to the wireless router. To check the router frequency, check with your Internet service provider or the router manufacturer.
	<p>The distance between the appliance and the router is too far.</p> <ul style="list-style-type: none"> If the distance between the appliance and the router is too far, the signal may be weak and the connection may not be configured correctly. Move the location of the router so that it is closer to the appliance.

Memo

Memo

Memo

